

MS SERIES III

30 kW to 75 kW DC Power Supply



LXI CE

For U.K Sales

 **TELONIC**

TEST INSTRUMENTS & POWER SUPPLIES

info@telonic.co.uk Tel:0118 9786911



**MAGNA-POWER
ELECTRONICS**

www.magna-power.com

MS SERIES III

Rugged Current-Fed Technology

Innovative and Scalable

Magna-Power Electronics MS Series combines the best of DC power processing with *microprocessor embedded control*. Magna-Power Electronics' innovative power processing technology improves response, shrinks package size, and reduces cost. MS Series power supplies are *current-fed* and are more tolerant to abusive loads than conventional switching power supplies. This technology allows the power supply to operate under short-circuit conditions, open-circuit conditions, and everything inbetween.

MS Series power supplies offer both *master/slave parallel and series* operation. This enables two or more power supplies to be placed in parallel for increased output current or in series for increased output voltage. With master/slave operation, power supplies operate at near equal voltage and current.

MS Series power supplies can operate as a *voltage source* or *current source* depending on the control settings and load conditions. If the power supply is operating as a voltage source and the load increases to a point beyond the current command setting, the power supply automatically crosses over to current mode control and operates as a current source at that setting.

Attention to Power Quality

MS Series power supplies contain circuitry to work harmoniously with other power equipment. Step-start contactors are used to keep inrush current below full scale operating current. Filter components lower current harmonic content emanating from the power supply and increase power factor to levels beyond 90%. Every power supply is tested at 90% to 125% nominal line to insure satisfactory operation even under the worst line voltage conditions.



KEY FEATURES:

- **Wide voltage and current range:**
0-16 Vdc to 0-4000 Vdc and 0-7.2 Adc to 0-4500 Adc
- **Wide range of input voltages as standard:**
From 208 Vac to 480 Vac at 50 Hz, 60 Hz, and 400 Hz
- **37-pin optically isolated user I/O circuitry standard:**
No additional isolation circuitry necessary
- **Front panel analog potentiometers:**
Stepless rotary control
- **High efficiency operation:**
Up to 88% efficiency under full load
- **RS232 interface standard with SCPI Commands:**
GPIB, USB, Ethernet, RS485 interfaces optional
- **Optional LXI-certified ethernet communications:**
Embedded web-server
- **OVT and OCT shutdown standard:**
Mechanical contactors disconnect input mains
- **Certified LabWindows/CVI, LabView, and IVI Drivers**
- **Programmable Output Modulation:**
With D panel, emulates user-defined power profiles
- **Automatic Voltage/Current Crossover**
- **Front Panel Calibration**

Designed for Safety

MS Series power supplies have extensive diagnostic functions -- all of which, when activated, take command to shut down the system. Diagnostic functions include phase loss, excessive thermal conditions, over voltage trip, over current trip, fuse clearing, and program line. Program line monitors externally applied analog set point signals to insure they are within the specified range. Upon a diagnostic fault condition, main power is disconnected and the diagnostic condition is latched into memory. Pressing the clear key clears the memory. All diagnostic functions can be monitored through a rear connector.

MS SERIES III

Models and Ratings



**MAGNA-POWER
ELECTRONICS**

30 kW Models

Model	Voltage (Vdc)	Current (Adc)	Ripple (mVrms)	Eff. %	Input Current (Aac)		
					208/240 V	380/415 V	440/480 V
MSA16-1800	0-16	0-1800	35	86	108	60	54
MSA20-1500	0-20	0-1500	40	86	108	60	54
MSA32-900	0-32	0-900	40	86	108	60	54
MSA40-750	0-40	0-750	40	87	108	60	54
MSA50-600	0-50	0-600	50	87	108	60	54
MSA80-372	0-80	0-372	60	87	108	60	54
MSA100-300	0-100	0-300	60	87	106	58	52
MSA125-240	0-125	0-240	100	87	106	58	52
MSA160-186	0-160	0-186	120	87	106	58	52
MSA200-150	0-200	0-150	125	87	106	58	52
MSA250-120	0-250	0-120	130	88	106	58	52
MSA375-78	0-375	0-78	170	88	106	58	52
MSA400-72	0-400	0-72	200	88	106	58	52
MSA500-60	0-500	0-60	220	88	106	58	52
MSA600-48	0-600	0-48	250	88	106	58	52
MSA800-36	0-800	0-36	300	88	106	58	52
MSA1000-30	0-1000	0-30	350	88	106	58	52
MSA1500-19.8	0-1500	0-19.8	400	88	106	58	52
MSA2000-15.0	0-2000	0-15.0	450	88	106	58	52
MSA3000-9.6	0-3000	0-9.6	500	88	106	58	52
MSA4000-7.2	0-4000	0-7.2	550	88	106	58	52

60 kW Models

Model	Voltage (Vdc)	Current (Adc)	Ripple (mVrms)	Eff. %	Input Current (Aac)		
					208/240 V	380/415 V	440/480 V
MSA16-3600	0-16	0-3600	35	86	216	120	108
MSA20-3000	0-20	0-3000	40	86	216	120	108
MSA32-1800	0-32	0-1800	40	86	216	120	108
MSA40-1500	0-40	0-1500	40	87	216	120	108
MSA50-1200	0-50	0-1200	50	87	216	120	108
MSA80-744	0-80	0-744	60	87	216	120	108
MSA100-600	0-100	0-600	60	87	212	116	104
MSA125-480	0-125	0-480	100	87	212	116	104
MSA160-372	0-160	0-372	120	87	212	116	104
MSA200-300	0-200	0-300	125	87	212	116	104
MSA250-240	0-250	0-240	130	88	212	116	104
MSA375-156	0-375	0-156	170	88	212	116	104
MSA400-144	0-400	0-144	200	88	212	116	104
MSA500-120	0-500	0-120	220	88	212	116	104
MSA600-96	0-600	0-96	250	88	212	116	104
MSA800-72	0-800	0-72	300	88	212	116	104
MSA1000-60	0-1000	0-60	350	88	212	116	104
MSA1500-39.6	0-1500	0-39.6	400	88	212	116	104
MSA2000-30.0	0-2000	0-30.0	450	88	212	116	104
MSA3000-19.2	0-3000	0-19.2	500	88	212	116	104
MSA4000-14.4	0-4000	0-14.4	550	88	212	116	104

45 kW Models

Model	Voltage (Vdc)	Current (Adc)	Ripple (mVrms)	Eff. %	Input Current (Aac)		
					208/240 V	380/415 V	440/480 V
MSA16-2700	0-16	0-2700	35	86	162	90	81
MSA20-2250	0-20	0-2250	40	86	162	90	81
MSA32-1350	0-32	0-1350	40	86	162	90	81
MSA40-1125	0-40	0-1125	40	87	162	90	81
MSA50-900	0-50	0-900	50	87	162	90	81
MSA80-558	0-80	0-558	60	87	162	90	81
MSA100-450	0-100	0-450	60	87	159	87	78
MSA125-360	0-125	0-360	100	87	159	87	78
MSA160-279	0-160	0-279	120	87	159	87	78
MSA200-225	0-200	0-225	125	87	159	87	78
MSA250-180	0-250	0-180	130	88	159	87	78
MSA375-117	0-375	0-117	170	88	159	87	78
MSA400-108	0-400	0-108	200	88	159	87	78
MSA500-90	0-500	0-90	220	88	159	87	78
MSA600-72	0-600	0-72	250	88	159	87	78
MSA800-54	0-800	0-54	300	88	159	87	78
MSA1000-45	0-1000	0-45	350	88	159	87	78
MSA1500-27.7	0-1500	0-27.7	400	88	159	87	78
MSA2000-22.5	0-2000	0-22.5	450	88	159	87	78
MSA3000-14.4	0-3000	0-14.4	500	88	159	87	78
MSA4000-10.8	0-4000	0-10.8	550	88	159	87	78

75 kW Models

Model	Voltage (Vdc)	Current (Adc)	Ripple (mVrms)	Eff. %	Input Current (Aac)		
					208/240 V	380/415 V	440/480 V
MSA16-4500	0-16	0-4500	35	86	270	150	135
MSA20-3750	0-20	0-3750	40	86	270	150	135
MSA32-2250	0-32	0-2250	40	86	270	150	135
MSA40-1875	0-40	0-1875	40	87	270	150	135
MSA50-1500	0-50	0-1500	50	87	270	150	135
MSA80-930	0-80	0-930	60	87	270	150	135
MSA100-750	0-100	0-750	60	87	265	145	130
MSA125-600	0-125	0-600	100	87	265	145	130
MSA160-465	0-160	0-465	120	87	265	145	130
MSA200-375	0-200	0-375	125	87	265	145	130
MSA250-300	0-250	0-300	130	88	265	145	130
MSA375-195	0-375	0-195	170	88	265	145	130
MSA400-180	0-400	0-180	200	88	265	145	130
MSA500-150	0-500	0-150	220	88	265	145	130
MSA600-120	0-600	0-120	250	88	265	145	130
MSA800-90	0-800	0-90	300	88	265	145	130
MSA1000-75	0-1000	0-75	350	88	265	145	130
MSA1500-49.5	0-1500	0-49.5	400	88	265	145	130
MSA2000-37.5	0-2000	0-37.5	450	88	265	145	130
MSA3000-24.0	0-3000	0-24.0	500	88	265	145	130
MSA4000-18.0	0-4000	0-18.0	550	88	265	145	130

Model Ordering System

Series Name	Front Panel	Output Voltage	Output Current	Input Voltage
XR	A: Analog	See Tables	See Tables	208 SP
TS	D: Digital			240 SP
MS	C: Computer			208
MT	Blank: XR			240
				380
				415
				440
				480

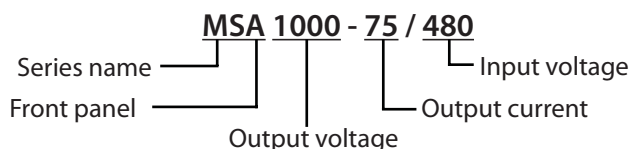

Options

- Custom output
- LXI TCP/IP Ethernet interface
- GPIO interface
- USB interface
- RS485 interface
- 240 Vac single-phase input (5 kW)

MS SERIES III

Reliable Control Technology



Remote Interface Software

The Remote Interface Software ships with all MS Series power supplies. The software provides the user with an easy and intuitive method to operate a Magna-Power Electronics' power supply with computer control. The Remote Interface Software has six windows:

- Virtual Control Panel
- Command Panel
- Register Panel
- Calibration Panel
- Firmware Panel
- Modulation Panel

The Virtual Control Panel emulates the MS Series front panel, the Command panel programs and reads SCPI commands with user friendly buttons, the Register Panel programs and reads registers, the Calibration Panel enables calibration of the digital potentiometers, the Firmware Panel enables the program stored internal to the power supply to be upgraded, and the Modulation Panel eases programming of modulation parameters.

Power Source Emulation

Output modulation enables Magna-Power Electronics' power supplies to emulate a variety of user-defined power sources, such as *Fuel Cells*, *Photovoltaic Arrays*, *Batteries*, etc. The power supplies follow an I-V curve programmed either through Magna-Power's Remote Interface Software (modulation panel), LabVIEW with certified NI LabVIEW drivers, or through other programming means using SCPI commands.

Isolated External I/O for Automation

Using the rear 37-pin I/O connector, the MS Series power supplies can be completely controlled and monitored using external signals. The voltage, current, over voltage trip, and over current trip set points are set by applying a 0-10 Vdc analog signals. Each diagnostic condition is given a designated pin, which reads 5 Vdc when high. Also, the power supply features an external interlock, which when enabled, allows the power supply to be tied in with other emergency stop equipment. All these pins are isolated to earth-ground as standard--no additional isolation circuitry necessary!

LXI Compliant Embedded Ethernet

LXI is an instrumentation platform based on industry standard Ethernet technology designed to provide modularity, flexibility and performance to small- and medium-sized systems. LXI's advantages are exemplified in its compact, flexible package providing high-speed I/O and reliable measurements. These features meet the needs of R&D and manufacturing engineers delivering electronics for the aerospace/defense, automotive, industrial, and medical markets.



Certified to the LXI Standard (Class C), the MS Series Ethernet option includes an embedded web-server, allowing web browser power supply control and monitoring from virtually anywhere.

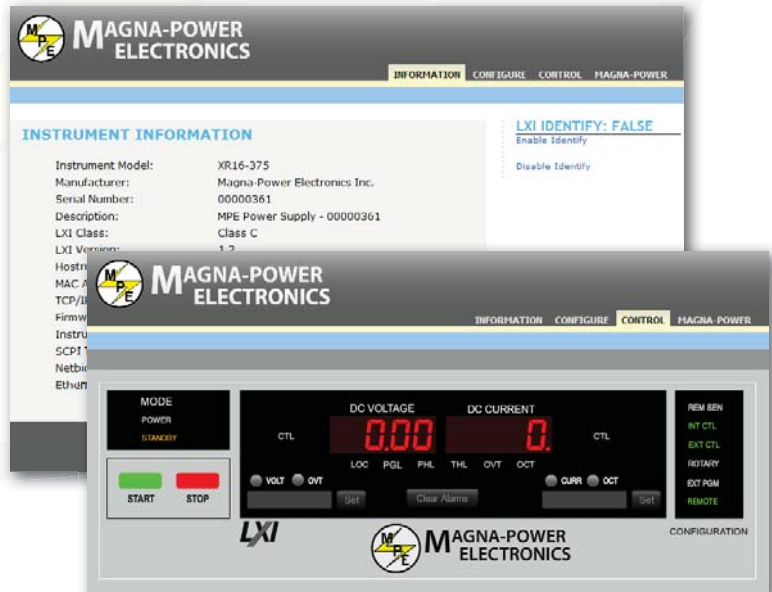

MS SERIES III

Enhanced Front Panel Control

A Version Front Panel

Switches main power on and off

Meters display voltage, current, over voltage protection, over current protection

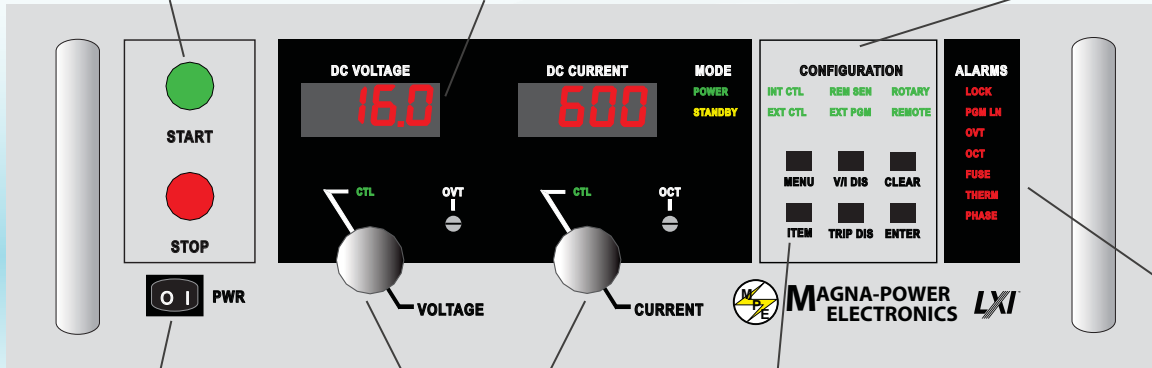

Energizes control circuits without turning the main power on

Sets voltage and current in rotary mode

FUNCTION KEYS
 MENU: Select function
 V/I DIS: Displays V/I set points
 CLEAR: Clear setting or reset fault

ITEM: Select item within function
 TRIP DIS: Displays OVT and OCT setting
 ENTER: Enter Setting

MODE AND CONFIGURATION
 POWER: Indicates power output
 STANDBY: Indicates control power only
 INT CTL: Front panel controls enabled
 EXT CTL: External controls enabled
 REM SEN: Indicates remote sense
 EXT PGM: External voltage/current control
 ROTARY: Potentiometer voltage/current control
 REMOTE: RS232 control enabled

ALARMS
 LOCK: Interlock
 PGM LINE: External input beyond limits
 OVT: Shows over voltage protection has tripped
 OCT: Show over current protection has tripped
 FUSE: Warns that a fuse has cleared
 THERM: Indicates overheating
 PHASE: Indicates a problem with the input voltage

D Version Front Panel

Switches main power on and off

Meters display voltage, current, over voltage protection, over current protection

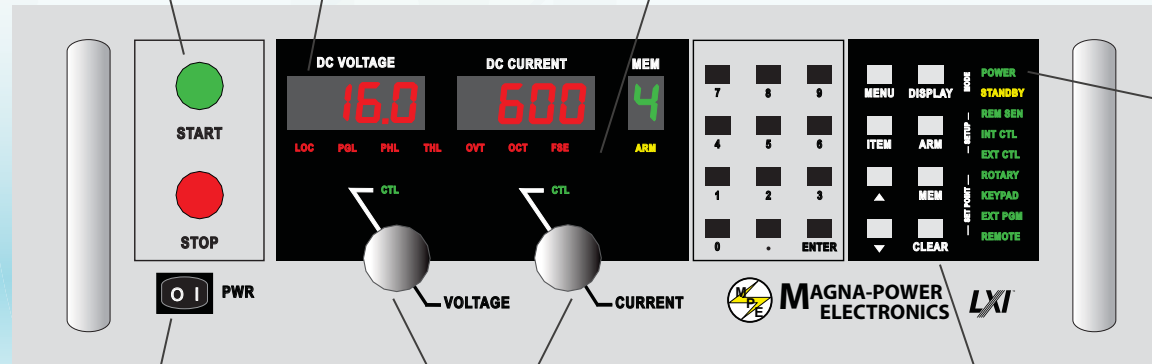

Energizes control circuits without turning the main power on

Sets voltage and current in rotary mode

ALARMS
 LOCK: Interlock
 PGM LINE: External input beyond limits
 OVT: Shows over voltage protection has tripped

OCT: Show over current protection has tripped
 FUSE: Warns that a fuse has cleared
 THERM: Indicates overheating
 PHASE: Indicates a problem with the input voltage

MODE AND CONFIGURATION
 POWER: Indicates power output
 STANDBY: Indicates control power only
 INT CTL: Front panel controls enabled
 EXT CTL: External controls enabled
 REM SEN: Indicates remote sense
 EXT PGM: External voltage/current control
 ROTARY: Potentiometer voltage/current control
 REMOTE: RS232 control enabled

FUNCTION KEYS
 MENU: Select function
 DISPLAY: Displays V/I set points
 ITEM: Select item within function
 ARM: arms power supply for auto sequencing through states stored in memory

ENTER: Enter Setting
 CLEAR: Clear setting or reset fault
 MEM: Sets memory
 ▲ : Up
 ▼ : Down

C Version Front Panel

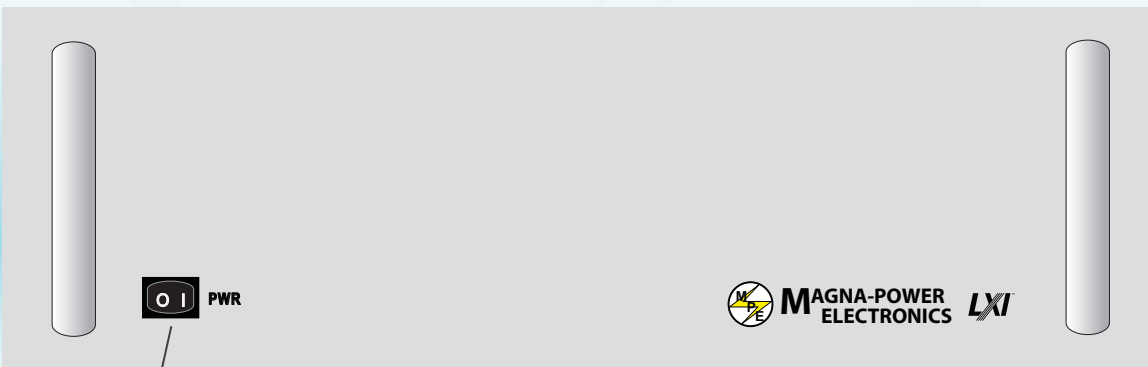

Energizes control circuits without turning the main power on

MS SERIES III

Specifications



Input

Nominal Voltage 3 phase, 3 wire + ground	208 VAC, 3φ (operating range 187 - 229 VAC)
	240 VAC, 3φ (operating range 216 - 264 VAC)
	380 VAC, 3φ (operating range 342 - 418 VAC)
	415 VAC, 3φ (operating range 373 - 456 VAC)
	440 VAC, 3φ (operating range 396 - 484 VAC)
	480 VAC, 3φ (operating range 432 - 528 VAC)
Frequency	50 Hz through 400 Hz
Power Factor	Greater than 92% at maximum power

Environmental

Operating Temperature	0 °C to 50 °C
Storage Temperature	-25 °C to 85 °C
Temperature Coefficient	0.04 / °C of maximum output current
Air Cooling	Front and rear intake, top exhaust Inlet temperature: 25°C maximum 1.5 GPM minimum flow rate for 15 kW units, 3.0 GPM minimum flow rate for 20 to 30 kW units 4.5 GPM minimum flow rate for 45 kW units
Water Cooling (Optional)	Pressure: 80 PSI maximum, Pipe size: 1/4" NPT female.

Physical

Dimensions (H" x W" x D")	30 kW: 38.5 x 22 x 29 in (97.8 x 55.9 x 73.7 cm)
	45 kW: 38.5 x 22 x 29 in (97.8 x 55.9 x 73.7 cm)
	60 kW: 38.5 x 22 x 29 in (97.8 x 55.9 x 73.7 cm)
	75 kW: 49 x 22 x 29 in (124.46 x 55.9 x 73.7 cm)
Weight	30 kW: 280 lbs (127.0 kg)
	45 kW: 395 lbs (179.2 kg)
	60 kW: 510 lbs (231.3 kg)
	75 kW: 645 lbs (292.6 kg)

Did you know?

Magna-Power Electronics power supplies:

- Are all designed, manufactured, and supported in the USA
- Can all be configured for master/slave parallel and series operation
- Have the widest range of input voltages and frequencies—all available at no additional cost
- Come standard with I/O isolation
- Have an added power-processing stage for superior performance

Output

Ripple	See Model Charts
Line Regulation	Voltage Mode: ± .004% of full scale
	Current Mode: ± .02% of full scale
Load Regulation	Voltage Mode: ± .01% of full scale
	Current Mode: ± .04% of full scale
Load Transient Response	2 ms to recover within ± 1% of regulated output, with a 50%-100% or 100%-50% step load change
Efficiency	≥ 86% (See Model Charts)
Stability	± 0.10% for 8 hrs. after 30 min. warmup
Maximum Slew Rate	100 ms for output voltage change from 0 to 63%
	100 ms for output current change from 0 to 63%
Isolation	Maximum input voltage to ground: ±2500 VAC
	For models less than or equal to 1000 Vdc: Maximum output voltage to ground: ±1000 VDC
	For models greater than 1000 Vdc: Maximum output voltage to ground: ±4000 VDC User I/O circuitry: referenced to earth ground

Programming Levels and Accuracy of Full Scale

	Voltage Set Point	Current Set Point	OVT Set Point	OCT Set Point
Remote Analog Programming Accuracy	± 0.50%	± 0.75%	± 0.50 %	± 0.75%
Digital Programming Accuracy	± 0.50%	± 0.75%	± 0.50 %	± 0.75%
Remote Analog Programming Levels	0 - 10.0 V	0 - 10.0 V	0 - 10.0 V	0 - 10.0 V

Monitoring Levels and Accuracy of Full Scale

	Output Voltage	Output Current
Remote Analog Monitoring Accuracy	± 0.50%	± 0.75%
Digital Monitoring Accuracy	± 0.50%	± 0.75%
Remote Analog Monitoring Levels	0 - 10.0 V	0 - 10.0 V

Control Limits

Remote Sense Limits	3% maximum voltage drop from output to load
Digital control inputs and outputs limits	Input voltage: 0 to 5 V
	Output voltage: 0 to 5 V, 5 mA drive capacity

MS SERIES III

Size Diagrams

Front Panel

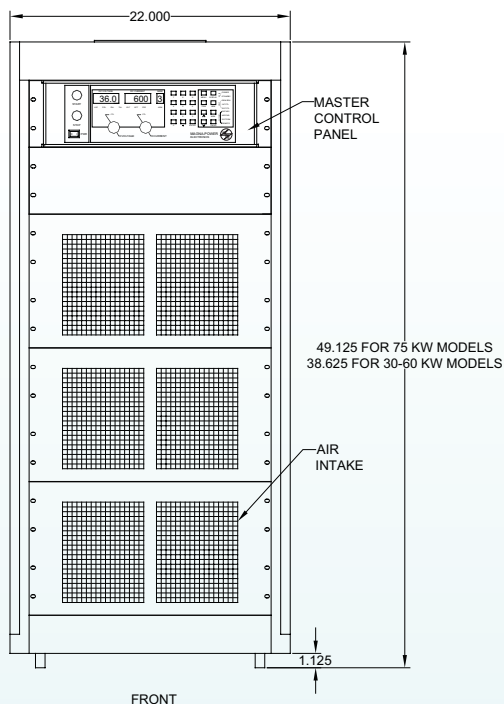

Rear Panel

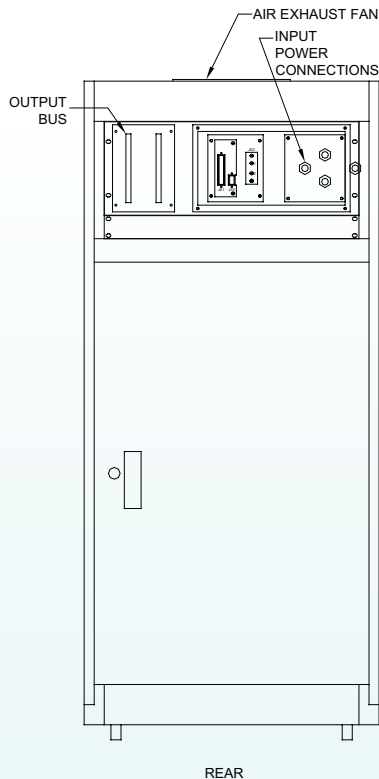

Connector JS1

TERM	PARAMETER	TERM	PARAMETER
1	REF GND	20	REF GND
2	REF GND	21	+10V REF
3	VREF EXT	22	IREF EXT
4	TVREF EXT	23	TIREF EXT
5	VO2	24	IO2
6	+2.5V REF CAL	25	VMOD
7	GND	26	+5V
8	POWER	27	PGM LINE
9	THERMAL	28	STANDBY
10	INTERLOCK	29	PHASE LOSS
11	CUR CTL	30	VOLT CTL
12	STANDBY/ALM	31	RESERVE
13	ALM	32	OCT
14	EXT CTL	33	INT CTL
15	FUSE	34	OVT
16	RESERVE	35	RESERVE
17	START	36	ARM
18	CLEAR	37	INTERLOCK SET
19	STOP		

Connector JS2

TERM	PARAMETER
1	VO1REM-
2	VO1REM+

Connector JS3

TERM	PARAMETER	TERM	PARAMETER
1	NC	1	NC
2	RX	2	RX
3	TX	3	TX
4	DTR	4	DTR
5	GND	5	GND
6	DSR	6	DSR
7	RTS	7	RTS
8	CTS	8	CTS
9	NC	9	NC

Output Bus

DETAILS OF OUTPUT BUS HIGH VOLTAGE UNITS

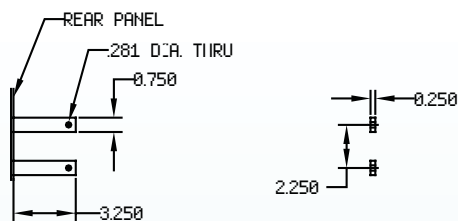

DETAILS OF OUTPUT BUS LOW/MEDIUM VOLTAGE UNITS

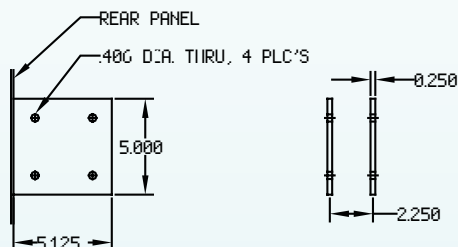

Interfaces

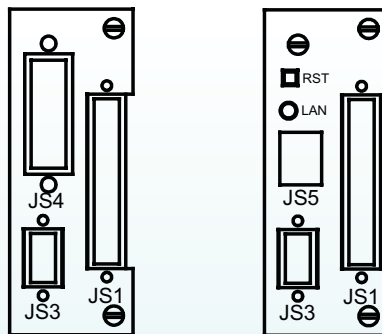

OPTIONAL IEEE-488 INTERFACE

OPTIONAL ETHERNET INTERFACE

Experience you can rely on.

With decades of experience, Magna-Power Electronics has honed its product line to provide robust current-fed power conversion along with user friendly sophisticated microprocessor control. Magna-Power Electronics' products can be found around the world processing power for national labs, industrial sites, and universities.

Our products have evolved by listening to our customers and working with them to find solutions to their problems. Our continual growth is based upon our innovative engineering, superior manufacturing methods, and dedicated employees. Today, all engineering and manufacturing is performed in Flemington, NJ.

Models and Ratings (Continued)

Automated Test Equipment (ATE)

High power density and isolated rear I/O make the XR Series the ideal DC power source for rackmount systems. The analog I/O port allows you to connect a programmable logic controller or other external controls to set voltage, current, trip points, and monitor all the power supply's diagnostics using industry standard +5 Vdc signals.

Automotive Drive Testing / Burn-in

Whether for developing hybrid / electric powertrains or testing and burning-in electric motors, our DC supplies are proven in the automotive industry. With high current capabilities, transient response, and robust safety features, our power supplies are applied to a large number of automotive applications.

Water Treatment, Electrolysis, and Chemical Processes

Low ripple, excellent controls, and high reliability make the XR Series a solid choice for applications in electrodeionization (EDI) and electrolysis. Our supplies can be found around the world powering EDI modules. For hydrogen production, high efficiency and advanced diagnostics make the XR Series a smart choice.

Research at Universities and National Labs

Magna-Power Electronics' products can be found in research facilities, universities, and national laboratories around the globe. Our wide range of output voltages, robust current-fed power processing technology, and commitment to our customers and their applications have differentiated us from the competition.

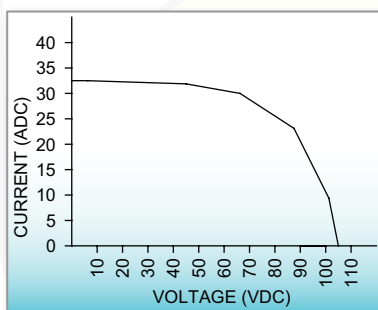

Power Source Emulation

Modulation enables the power supply to emulate different sources: such as batteries, fuel cells, photovoltaic arrays, etc. This emulation is accomplished by programming the output voltage or current to respond to an input variable using the Remote Interface Panel or with SCPI commands. The figure on the left illustrates the programmed piecewise linear approximation for a typical photovoltaic array. Alternatively, an I-V curve can be set using LabView using Magna-Power Electronics certified Labview drivers.

IV characteristics for a typical photovoltaic array

Battery Charging

A temperature compensated battery charger for applications with lead acid batteries. Diode D1, placed between the power supply and battery, blocks current from flowing from the battery to the power supply. This eliminates any loading on the battery when the power supply is off and prevents the battery from charging the power supply's output capacitors. Remote sensing should be applied across the battery terminals to compensate for the diode drop. By setting the voltage and current to the bulk charge voltage and maximum charge current, the power supply will initially charge the batteries in current mode control and then automatically crossover to voltage mode control when the batteries reach the desired set point. The power supply can be programmed for time dependent, sequential step operation to equalize and float charge the batteries after bulk charging.

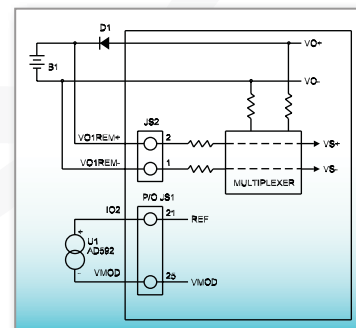

Temperature compensated battery charger